

INDUSTRIAL 工业 . AUTOMOTIVE 汽车 . AUTOMATION 自动化 . ENERGY 能源

# EFFECTIVE ENERGY SOLUTIONS



# INTELLIGENT SOLUTIONS FOR MORE EFFICIENCY AND SAFETY

更高效更安全的  
先进解决方案

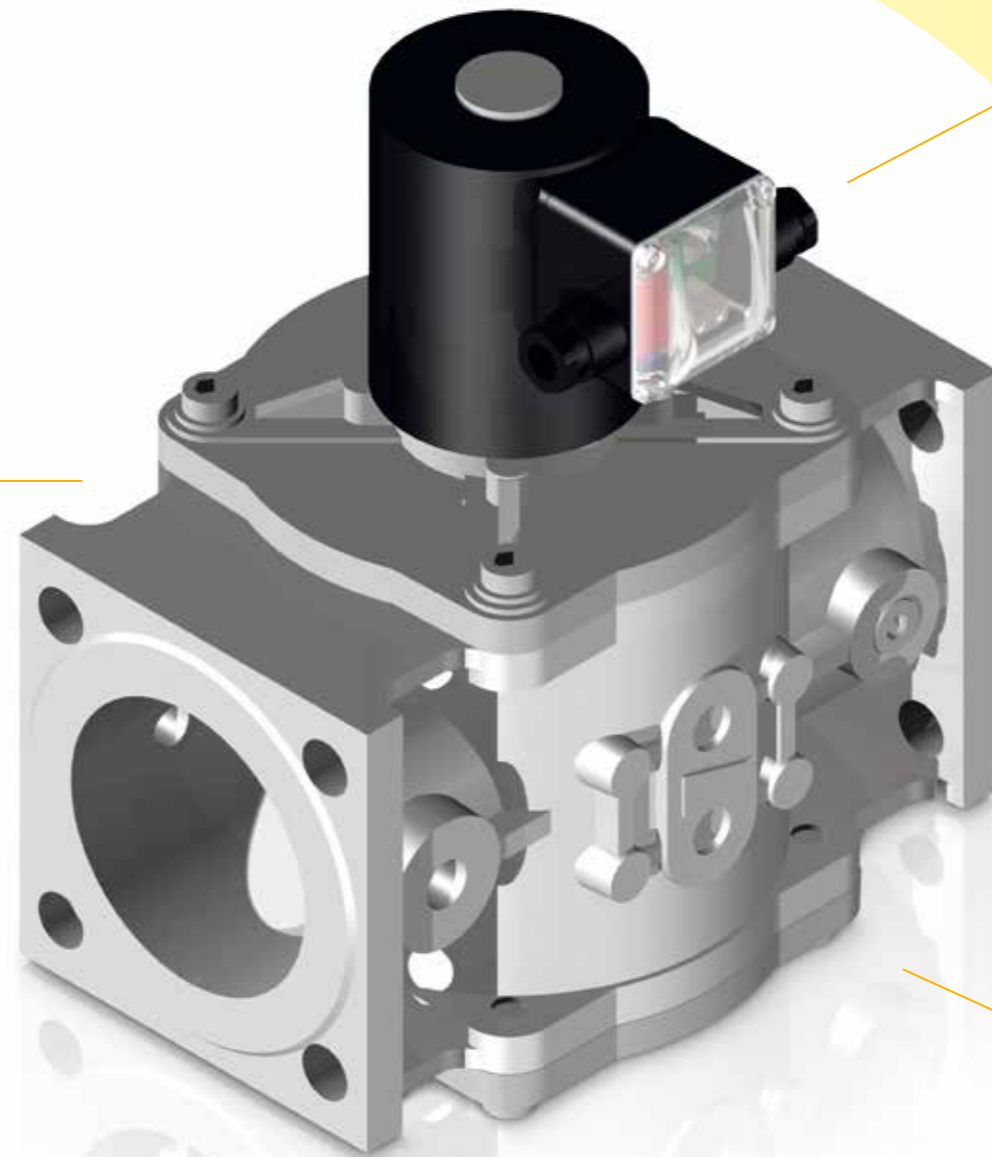

CE AND EN 161 CERTIFIED

CE及EN认证

ENERGY SAVING MODULE  
WITH LED INDICATION

节能模块  
带有LED指示灯

FLANGE OR THREAD  
CONNECTION

法兰或者螺纹  
连接

DN 15 UP TO DN 300

DN15到DN300

HIGH-PRECESSION ALUMINUM  
OR STEEL HOUSING

高精铝或者  
钢制阀体

# QUALITY AND INNOVATIONS FROM GERMANY

## 来自德国的品质保证和创新

FOUNDED IN 1974, PETERS INDU PRODUKT HAS DEVELOPED INTO A COMPANY THAT OPERATES ON AN INTERNATIONAL BASE. PERFECTION IS OUR CONSTANT AIM AND TECHNICAL KNOWLEDGE IS THE TOOL WE USE TO ACHIEVE IT. WITH THIS STRATEGY, WE HAVE DEVELOPED A STANDARD OF QUALITY THAT HAS CONTINUALLY CONVINCED CUSTOMERS WORLDWIDE. WE ARE CONSTANTLY EXPANDING OUR PRODUCT PORTFOLIOS IN THE INDUSTRIAL, AUTOMOTIVE, AUTOMATION AND ENERGY FIELDS. MOREOVER, WE DEVELOP TAILOR-MADE SOLUTIONS THAT SUIT THE NEEDS OF OUR CUSTOMERS – RIGHT FROM THE INITIAL IDEA TO THE FINISHED PRODUCT.

PETERS INDU PRODUKT成立于1974年，现已发展为一家全球性的公司。完美是我们一直坚持的目标，技术是我们的用以完成此目标的工具。在此战略下，我们的质量标准一直让我们世界各地的客户保持满意。我们在工业、工程行走机械、自动化以及能源行业持续扩展自己的产品范围。除此以外，我们还可以开发客户定制的产品，从而满足客户的需求 – 从最初的构思到最终的成品。



Our “Energy” business field comprises **safety valves, gas filters, regulators and PWM energy-saving modules** for liquids and gas families 1, 2 and 3 and other non-aggressive gases. We test our products thoroughly and ensure **that they function perfectly within a broad outdoor temperature range from  $-30^{\circ}\text{C}$  to  $+70^{\circ}\text{C}$** . Their ability to be combined makes them ideal for use in gas burners, gas engines, gas distribution and many other applications. Our entire range of products is synonymous with **outstanding quality and reliability**.

**Please feel free to contact us if you have any questions.**



我们的“能源”业务单元包含安全切断阀、燃气过滤器、调压器以及PWM节能模块，可用在液体以及I, II, III类燃气和其他非腐蚀性气体上。我们的产品经过严格的测试，并能够保证在  $-30^{\circ}\text{C}$  到  $+70^{\circ}\text{C}$  的温度范围内他们的性能都是优异的。它们可以被理想的应用于燃气燃烧器、燃气发动机、燃气传输系统以及其他很多应用上。我们所有的产品都拥有出众的质量和可靠性。

**如果您有任何问题，请随时联系我们。**

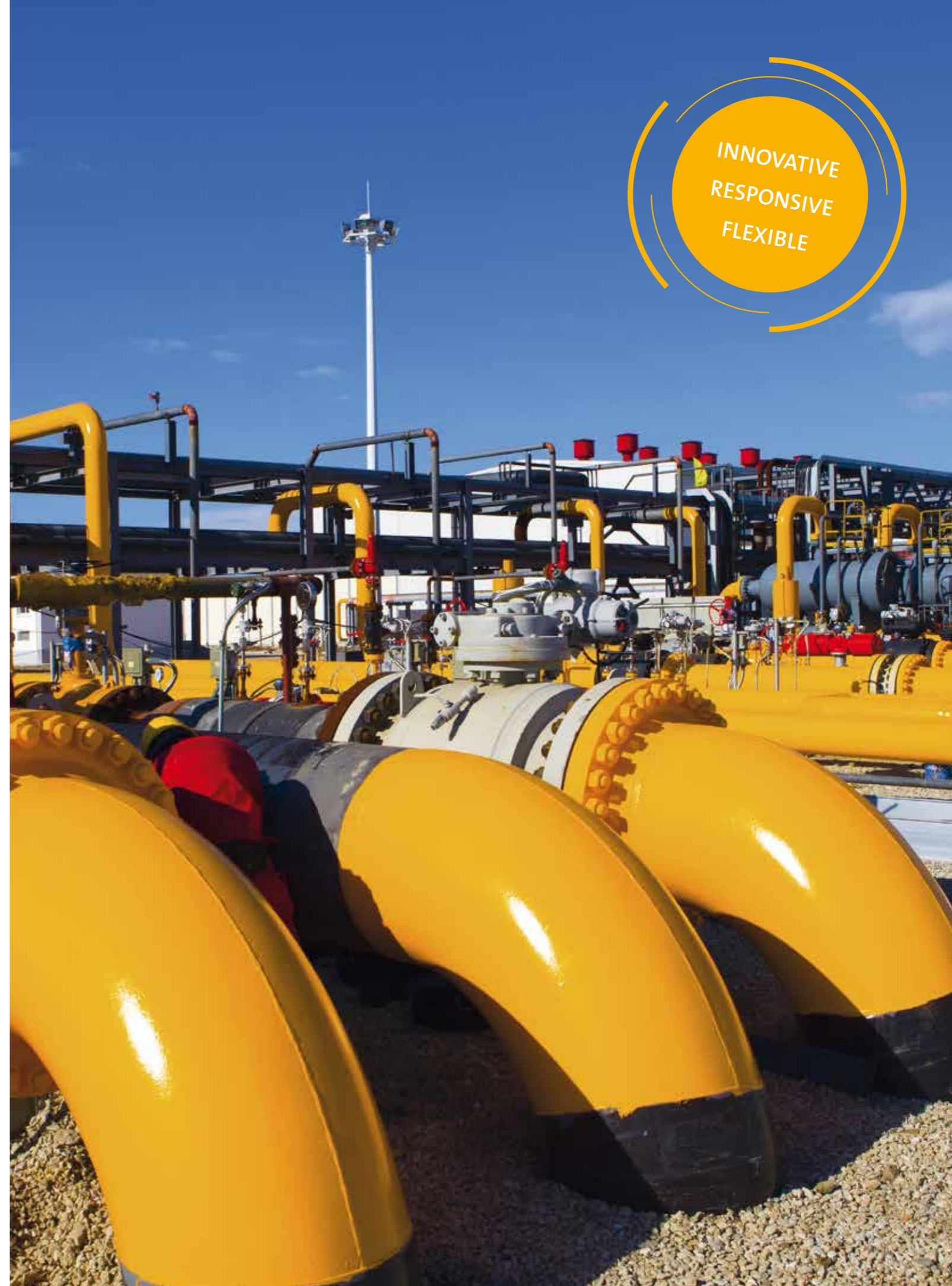

## GAS SAFETY VALVE – PH/PF-SERIES

### SINGLE STAGE VERSION

#### 燃气安全阀-PH/PF系列 单段式

Gas Safety Valve  
DN 15 up to DN 20 EN 161  
燃气安全电磁阀  
DN15到DN20, EN161



Gas Safety Valve  
DN 65 up to DN 300 EN 161  
燃气安全电磁阀  
DN65到DN300, EN161



#### DETAILS

- \_ Position indicator optional
- \_ EN 161, class A
- \_ Normally closed/normally open ( DN 15, 20, 25)
- \_ DN 15 to DN 300
- \_ Fast open – fast close
- \_ 24 VDC or 230 VAC
- \_ ED 100%
- \_ Puls Width Module equipped
- \_ 200 mBar up to 6 Bar
- \_ Aluminum or Steel housing
- \_ -30°C up to 70°C
- \_ IP65 protection class
- \_ Threaded or flange connection

#### 详情

- \_ 阀门位置指示开关 - 选配
- \_ EN161, A级
- \_ 常闭 / 常开 (DN 15, 20, 25)
- \_ DN 15到 DN300
- \_ 快开快关
- \_ 24 VDC或者230VAC
- \_ ED 100%
- \_ 装备有脉宽调节装置
- \_ 200 mbar到6 bar
- \_ 铝制或钢制阀体
- \_ -30° C到70° C
- \_ 防护等级IP65
- \_ 螺纹或者法兰连接

## GAS SAFETY VALVE – PH-SERIES

### DUAL STAGE VERSION

#### 燃气安全阀-PH/PF系列 双段式

Gas Safety Valve  
DN 20 dual stage  
燃气安全电磁阀  
DN20两段式



Gas Safety Valve  
DN 50 dual stage  
燃气安全电磁阀  
DN50两段式



#### DETAILS

- \_ Position indicator optional
- \_ EN 161, class A
- \_ Normally closed
- \_ DN 20 to DN 50
- \_ Fast open – fast close
- \_ 24 VDC or 230 VAC
- \_ ED 100%
- \_ Puls Width Module equipped
- \_ 200 mBar up to 3 Bar
- \_ Aluminum or Steel housing
- \_ -30°C up to 70°C
- \_ IP65 protection class
- \_ Threaded or flange connection

#### 详情

- \_ 阀门位置指示开关 - 选配
- \_ EN161, A级
- \_ 常闭
- \_ DN 20 到DN50
- \_ 快开快关
- \_ 24 VDC或者230VAC
- \_ ED 100%
- \_ 装备有脉宽调节装置
- \_ 200 mbar到3 bar
- \_ 铝制或钢制阀体
- \_ -30° C到70° C
- \_ 防护等级IP65
- \_ 螺纹或者法兰连接

## GAS SAFETY VALVE SLOW OPEN MODE

### 燃气安全阀 慢开



Gas Safety Valve  
DN 25 slow open mode  
燃气安全电磁阀  
DN25慢开

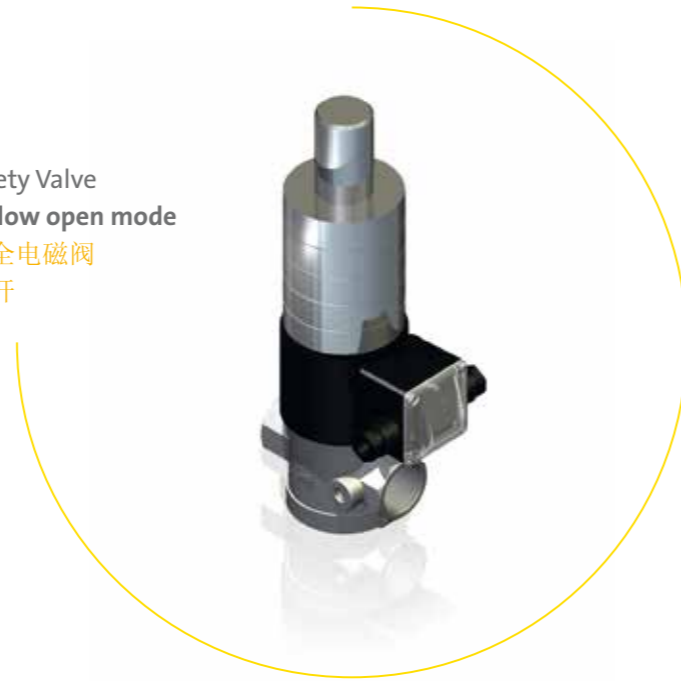

Gas Safety Valve  
DN 65 slow open mode  
燃气安全电磁阀  
DN65慢开

#### DETAILS

- \_ EN 161, class A
- \_ Normally closed
- \_ Slow open – fast close
- \_ DN 25 to DN 100
- \_ Aluminum housing
- \_ 5 to 40 Seconds opening time
- \_ 1 sec closing time
- \_ 24 VDC or 230 VAC
- \_ ED 100%
- \_ Pulse Width Module equipped
- \_ -30°C up to 70°C
- \_ IP65 protection class
- \_ 500 mBar up to 6 Bar
- \_ Threaded or flange connection

#### 详情

- \_ EN 161, A级
- \_ 常闭
- \_ 慢开快关
- \_ DN25到DN100
- \_ 铝制阀体
- \_ 5到40秒开启时间
- \_ 关闭时间小于1秒
- \_ 24 VDC或230 VAC
- \_ ED 100%
- \_ 装备有脉宽调节装置
- \_ -30° C 到 70° C
- \_ 防护等级IP65
- \_ 500mbar到6bar
- \_ 螺纹或法兰连接

## GAS MODULATING VALVES PM-SERIES

### 燃气调节阀 PM系列



Gas Modulating Valve  
DN 65  
燃气流量调节阀

#### DETAILS

- \_ DN 40 to DN 100
- \_ Proportional signal ( 3 Step)
- \_ 2 Way signal (2 step)
- \_ Switch frequency 40/hr
- \_ Service interval 200.000 cycles
- \_ Aluminum or Steel housing
- \_ Resistance transmitter  
100 Ohm/2 kOhm or 4 to 20 mA
- \_ -30°C up to 70°C
- \_ Rated pressure max. 6 Bar
- \_ 230 VAC
- \_ Power consumption 20w
- \_ Threaded or flange connection
- \_ Return spring

#### 详情

- \_ DN40到DN100
- \_ 比例信号
- \_ 开关信号
- \_ 开关频率 40次/小时
- \_ 维护周期 200000次
- \_ 铝制或钢制阀体
- \_ 电阻传感器  
100 Ohm / 2 kOhm 或4 到20 mA
- \_ -30° C 到 70° C
- \_ 最高工作压力 6 Bar
- \_ 230 VAC
- \_ 功率消耗20w
- \_ 螺纹或法兰连接
- \_ 复位弹簧

## GAS SAFETY VALVE WITH MODULATING FUNCTION

### 带流量调节功能的 燃气安全阀

Gas Safety Valve  
DN 40 with modulating function  
燃气安全电磁阀  
DN40带流量调节功能



Gas Safety Valve  
DN 65 with modulating function  
燃气安全电磁阀  
DN65带流量调节功能



#### DETAILS

- \_ EN 161, class A
- \_ DN 40 to DN 300
- \_ Threaded or flange connection
- \_ Aluminum or Steel housing
- \_ 500 mBar up to 3 Bar pressure range
- \_ Position indicator optional
- \_ 24 VDC or 230 VAC (coil) ED 100%
- \_ 24 VDC, 0.4 to 1W power consumption ( Actuator)
- \_ Switch frequency 500/hr
- \_ Resistance transmitter  
100 Ohm/2k Ohm or 4 to 20 mA
- \_ -30°C up to 70°C
- \_ IP65 Valve/IP54 Actuator

#### 详情

- \_ EN 161, A级
- \_ DN 40到DN 300
- \_ 螺纹或法兰连接
- \_ 铝制或钢制阀体
- \_ 最大工作压力500mbar到3bar
- \_ 阀位指示可选
- \_ 24 VDC或230 VAC(线圈) ED100%
- \_ 24 VDC, 0.4 到1W能量消耗 ( 执行器)
- \_ 开关频率500次/小时
- \_ 电阻传感器  
100 Ohm/ 2k Ohm 或4 到 20 mA
- \_ -30° C 到 70° C
- \_ 阀门防护等级IP65 /执行器防护等级IP54

## GAS FILTERS FT-SERIES

### 燃气过滤器 FT系列

Gas Filters  
FT-Series DN 20  
燃气过滤器  
FT系列DN20



Gas Filters  
FT-Series DN 65  
燃气过滤器  
FT系列DN65



#### DETAILS

- \_ DN 15 to DN 300
- \_ Threaded or flange connection
- \_ Aluminum or Steel housing
- \_ Rated pressure 6 Bar max
- \_ FCI-Module (electronically filter contamination indicator) or mechanical indicator with inspection window
- \_ Pore width 50 µm
- \_ Differential pressure 100 mBar
- \_ Ambient temperature -30°C up to 90°C

#### 详情

- \_ DN 15到DN 300
- \_ 螺纹或法兰连接
- \_ 铝制或钢制阀体
- \_ 最高工作压力6bar
- \_ FCI 模块(电子式过滤器污染指示器或带检视窗的机械式指示器)
- \_ 过滤精度50微米
- \_ 最大允许压差100mbar
- \_ 环境温度 -30° C 到 90° C

## ENERGY SAVING MODULE FOR OPTIMISED POWER MANAGEMENT IN SOLENOID VALVES

### 节能模块 电磁阀的最优化能耗管理

PWM  
Energy Saving Module  
PWM节能模块



#### DETAILS

- \_ Software-based module to optimise the power consumption of solenoids
- \_ Build-in or adapter version
- \_ Improved fluid performance
- \_ Increase flow rate and pressure
- \_ Decreasing the heat of the coil
- \_ Up to 92% energy savings
- \_ Useable for most solenoids
- \_ Operating voltage from 6 V DC up to 400 V AC
- \_ Max power 2000W(VA)

#### 详情

- \_ 基于软件的电磁线圈能耗最优化模块
- \_ 内置或者外置适配模式
- \_ 改善流体性能
- \_ 增加流体流量和压力
- \_ 降低线圈产生的热量
- \_ 最高节省92%的能量
- \_ 可用在大多数电磁线圈上
- \_ 工作电压从6V DC到400V AC
- \_ 最大功率2000W (VA)

## REGULATORS PR-SERIES 调压器PR系列

Regulator PR-Series  
调压器PR系列



#### DETAILS

- \_ EN 88, class A
- \_ DN15 to DN100
- \_ Max. operating pressure 0.5Bar or 6Bar
- \_ Accuracy: ±10%
- \_ -30 to 70°C (-40°C on request)
- \_ Aluminum
- \_ Safety relief valve optional

#### 详情

- \_ EN88, A级
- \_ DN15到DN100
- \_ 最大工作压力500mbar或6bar
- \_ 精度10%
- \_ -30到70° C (-40° C请咨询)
- \_ 铝制阀体
- \_ 安全放散阀可选

## ORDER KEY VALVES

### 1. SERIES

P – Series

### 2. VERSION

H – normally closed

F – normally open

M – modulating

### 3. MATERIAL

A – Aluminum

S – Steel

### 4. NOMINAL DIAMETER (DN)

15, 20, 25, 32, 40, 50, 65, 80, 100, 150, 200, 250, 300

NOTE:

DN 15 to DN 20 Threaded

DN 25 to DN 50 Threaded or Flange, Please indicate **F** for flange (i.e. 25F)

DN 65 to DN 300 Flange

### 5. VOLTAGE

A – 230 VAC

D – 24 VDC

### 6. TYPE

H – single stage

B – dual stage

C – liquid

M – with electric power drive

T – 1 Stage slow opening mode

### 7. PRESSURE RANGE

02 – 200 mBar

05 – 500 mBar

1 – 1 Bar

2 – 2 Bar

3 – 3 Bar

4 – 4 Bar

6 – 6 Bar

### 8. ACCESSORIES

X – without any accessories

K – with gas flow adjustment

P – position indicator

E – EX proof

EXAMPLES FOR  
ORDER KEY VALVES

P

H

A

25

A

H

1

K

P

H

A

25F

A

H

1

K

## 阀门订货编号

### 1. 系列

P – 阀门系列

### 2. 类别

H – 常闭

F – 常开

M – 调节

### 3. 材质

A – 铝制

S – 钢制

### 4. 公称直径 (DN)

15, 20, 25, 32, 40, 50, 65, 80, 100, 150, 200, 250, 300

说明:

DN 15 到 DN 20 螺纹连接

DN 25 到 DN 50 螺纹或法兰连接, 法兰连接请标明F (例如. 25F)

DN 65 到 DN 300 法兰连接

### 5. 电压

A – 230 VAC

D – 24 VDC

### 6. 形式

H – 单段式

B – 双段式

C – 液体

M – 带流量调节阀

T – 单端慢开

### 7. 压力范围

02 – 200 mBar

05 – 500 mBar

1 – 1 Bar

2 – 2 Bar

3 – 3 Bar

4 – 4 Bar

6 – 6 Bar

### 8. 附加功能

X – 标准型, 无附加功能

K – 最大流量手动调节

P – 阀位指示

E – 防爆

订货编号  
示例

P

H

A

25

A

H

1

K

P

H

A

25F

A

H

1

K



# ORDER KEY GAS FILTERS

## 1. SERIES

FT – Gas Filter Series

## 2. NOMINAL DIAMETERS DN

A – (Aluminum) 15, 20, 25, 40, 50, 65, 80, 100

S – (Steel) 25, 40, 50, 65, 80, 100, 150, 200, 250, 300

C – (Cast Iron) 150, 200

NOTE:

DN 15 to DN 20 Threaded

DN 25 to DN 50 Threaded or Flange, Please indicate **F** for flange (i.e. 25F)

DN 65 to DN 300 Flange



## 3. VERSION

A – Short Type

B – 1 Long Type

C – 2 Long Type

## 4. PRESSURE RANGE

3 – 3 Bar

6 – 6 Bar

EXAMPLES FOR  
ORDER KEY GAS FILTERS

FT A 2 5 A 3

FT A 2 5 F A 3

# 燃气过滤器订货编号

## 1. 系列

FT – 过滤器系列

## 2. 公称直径 DN

A – (铝制) 15, 20, 25, 40, 50, 65, 80, 100

S – (钢制) 25, 40, 50, 65, 80, 100, 150, 200, 250, 300

C – (铸铁) 150, 200

说明:

DN 15 to DN 20 螺纹连接

DN 25 to DN 50 螺纹或法兰连接, 法兰连接请标明F (例如. 25F)

DN 65 to DN 300 法兰连接



## 3. 形式

A – 短型

B – 长型1

C – 长型2

## 4. 压力范围

3 – 3 Bar

6 – 6 Bar

过滤器订货编号  
示例

FT A 2 5 A 3

FT A 2 5 F A 3

# ORDER KEY REGULATORS

## 1. SERIES

PR – Peters regulator ( PR-Series)

## 2. NOMINAL DIAMETERS DN

15, 20, 25, 40, 50, 65, 80, 100, 150, 200, 250, 300

(F for flange version)

## 3. PRESSURE RANGE

A – 0.5 Bar

B – 6 Bar

## 4. VERSION

X – standard version

C – with safety relief

## 5. OUTLET PRESSURE RANGE (mbar)

for A – 0.5 Bar Version

1 – brown – 2.5 to 9

2 – white – 5 to 13

3 – orange – 5 to 20

4 – blue – 10 to 30

5 – red – 25 to 55

6 – yellow – 30 to 70

7 – black – 60 to 110

8 – pink – 100 to 150

9 – grey – 140 to 200

for B – 6 Bar Version

A – Range A

B – Range B

C – Range C

EXAMPLES FOR  
ORDER KEY REGULATORS

PR 5 0 A C 3

PR 5 0 F A C 3

### Outlet Pressure range for 6 Bar version

Size	Range A	Range B	Range C
DN15, 20	90-200	120-270	240-570
DN25	80-160	100-230	180-520
DN32 to DN50	80-180	160-260	250-450
DN65 to DN80	80-200	110-300	160-390
DN 100	80-140	100-180	160-240

# 调压器订货编号

## 1. 系列

PR – Peters调压器

## 2. 公称直径DN

15, 20, 25, 40, 50, 65, 80, 100, 150, 200, 250, 300

(法兰连接标注F)

## 3. 压力范围

A – 0.5 Bar

B – 6 BAR

## 4. 版本

X – 标准版本

C – 带有安全放散阀

## 5. 出口压力范围 (MBAR)

for A – 0.5bar版本

1 – 棕色 – 2.5到9

2 – 白色 – 5到13

3 – 橙色 – 5到20

4 – 蓝色 – 10到30

5 – 红色 – 25到55

6 – 黄色 – 30到70

7 – 黑色 – 60到110

8 – 粉色 – 100到150

9 – 灰色 – 140到200

for B – 6bar版本

A – 范围A

B – 范围B

C – 范围C

EXAMPLES FOR  
ORDER KEY REGULATORS

PR 5 0 A C 3

PR 5 0 F A C 3

### 出口压力范围 (6bar版)

口径	范围A	范围B	范围C
DN15, 20	90-200	120-270	240-570
DN25	80-160	100-230	180-520
DN32 to DN50	80-180	160-260	250-450
DN65 to DN80	80-200	110-300	160-390
DN 100	80-140	100-180	160-240

# FLOW CHARTS

## 流量图

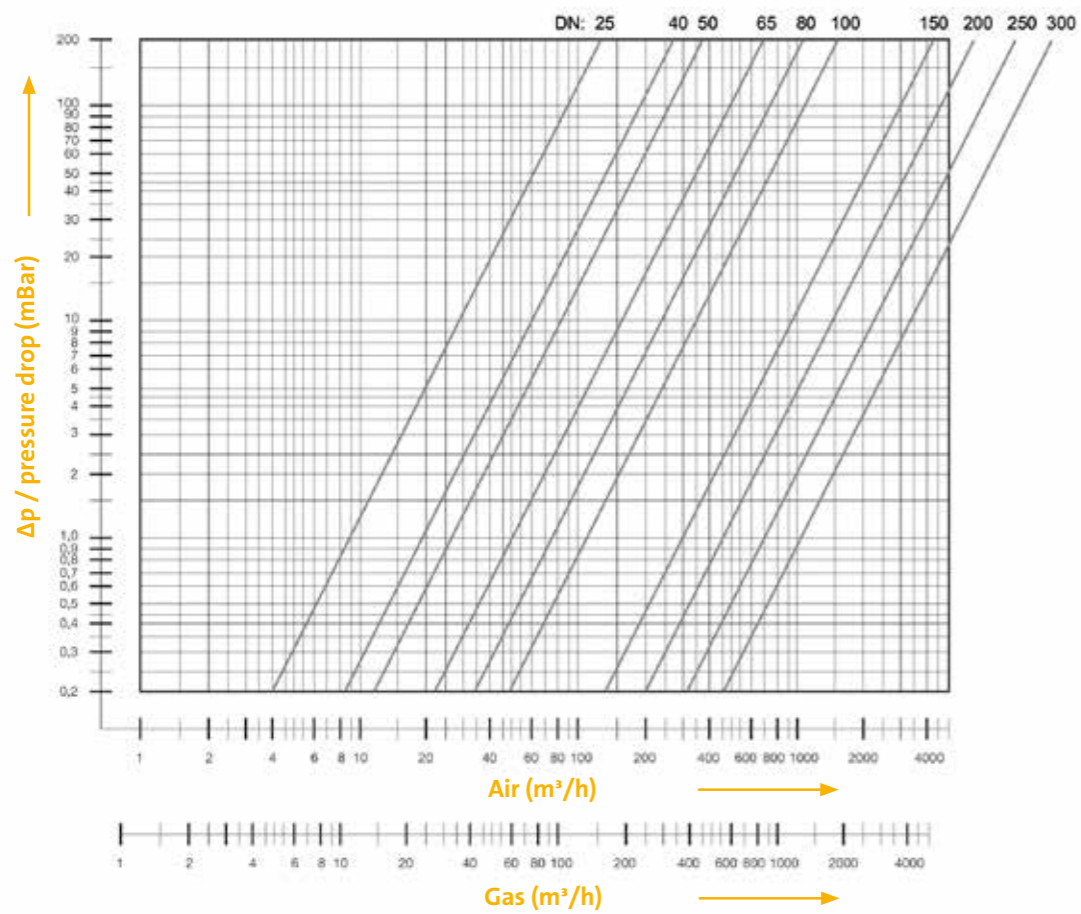
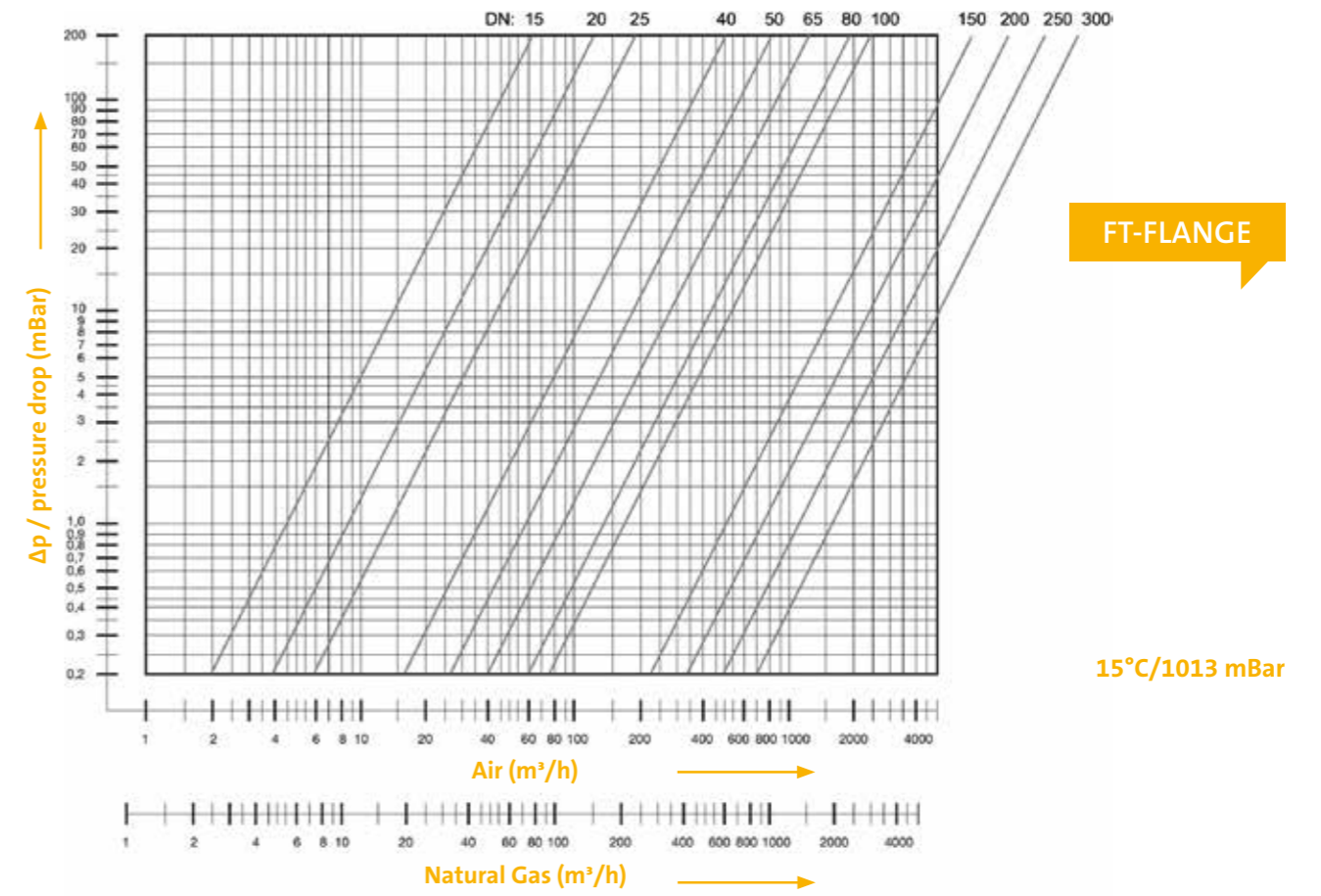
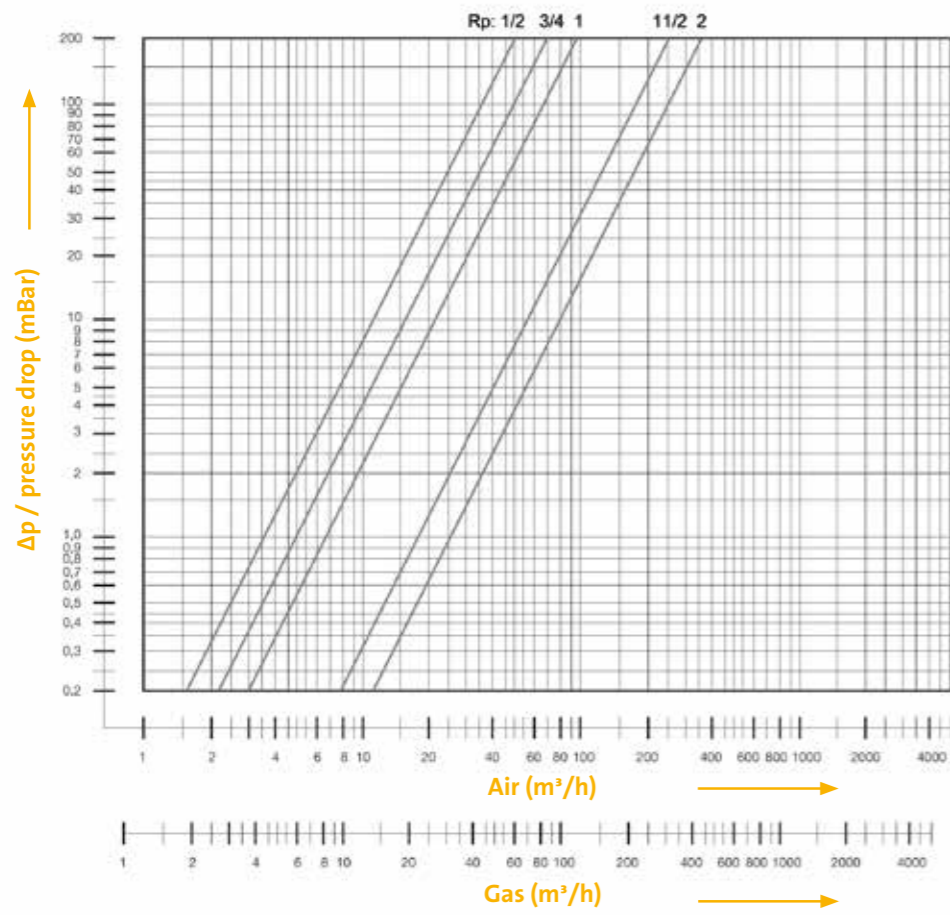

INCH 英寸	DN 公称直径	CONNECTION 连接方式
1/2 3/4	15 20	Threaded 螺纹
1 1 1/4 1 1/2 2	25 32 40 50	Threaded or Flange 螺纹或法兰
2 1/2 3 4 5 6 8 10 12	65 80 100 125 150 200 250 300	Flange 法兰

# NOTES

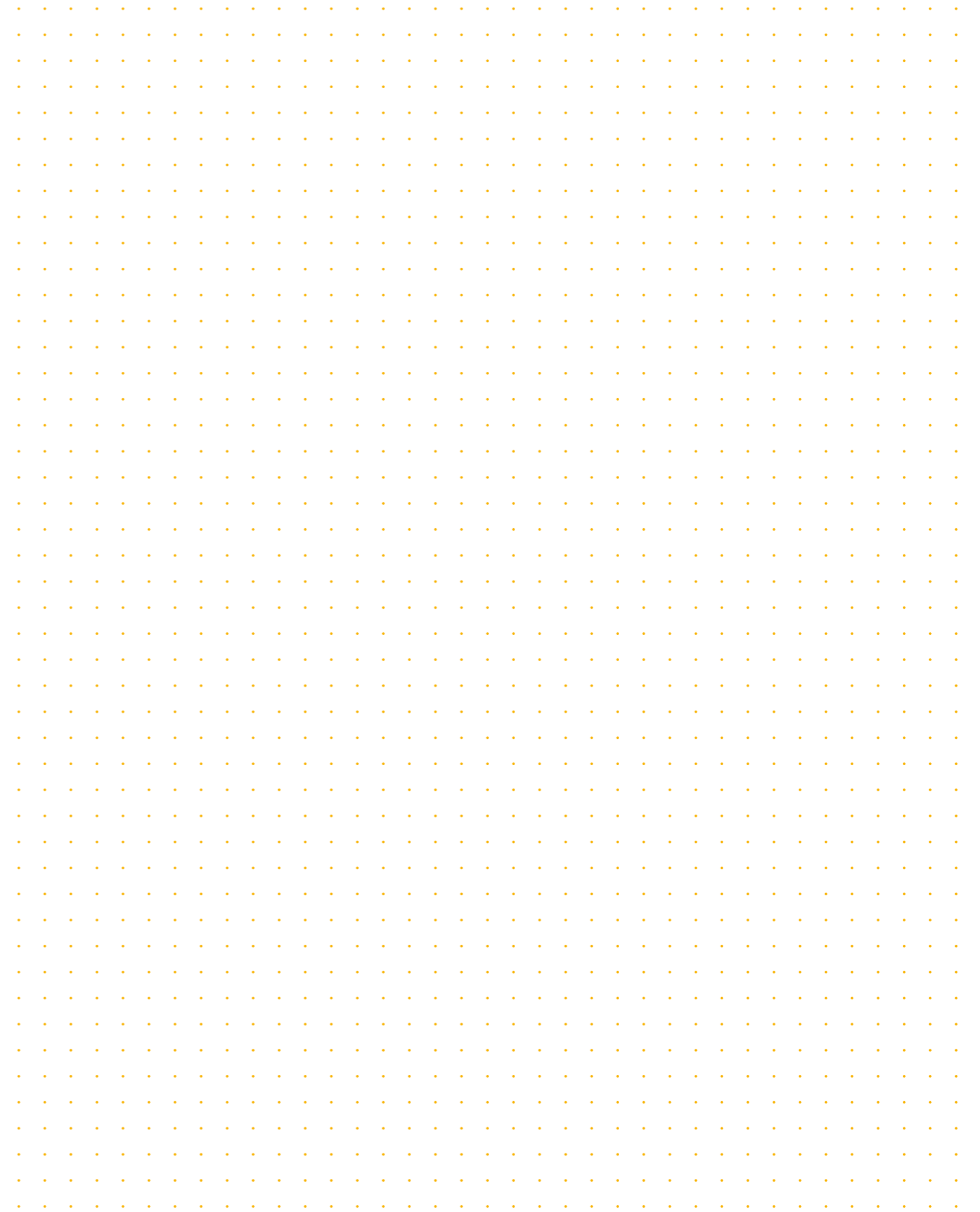
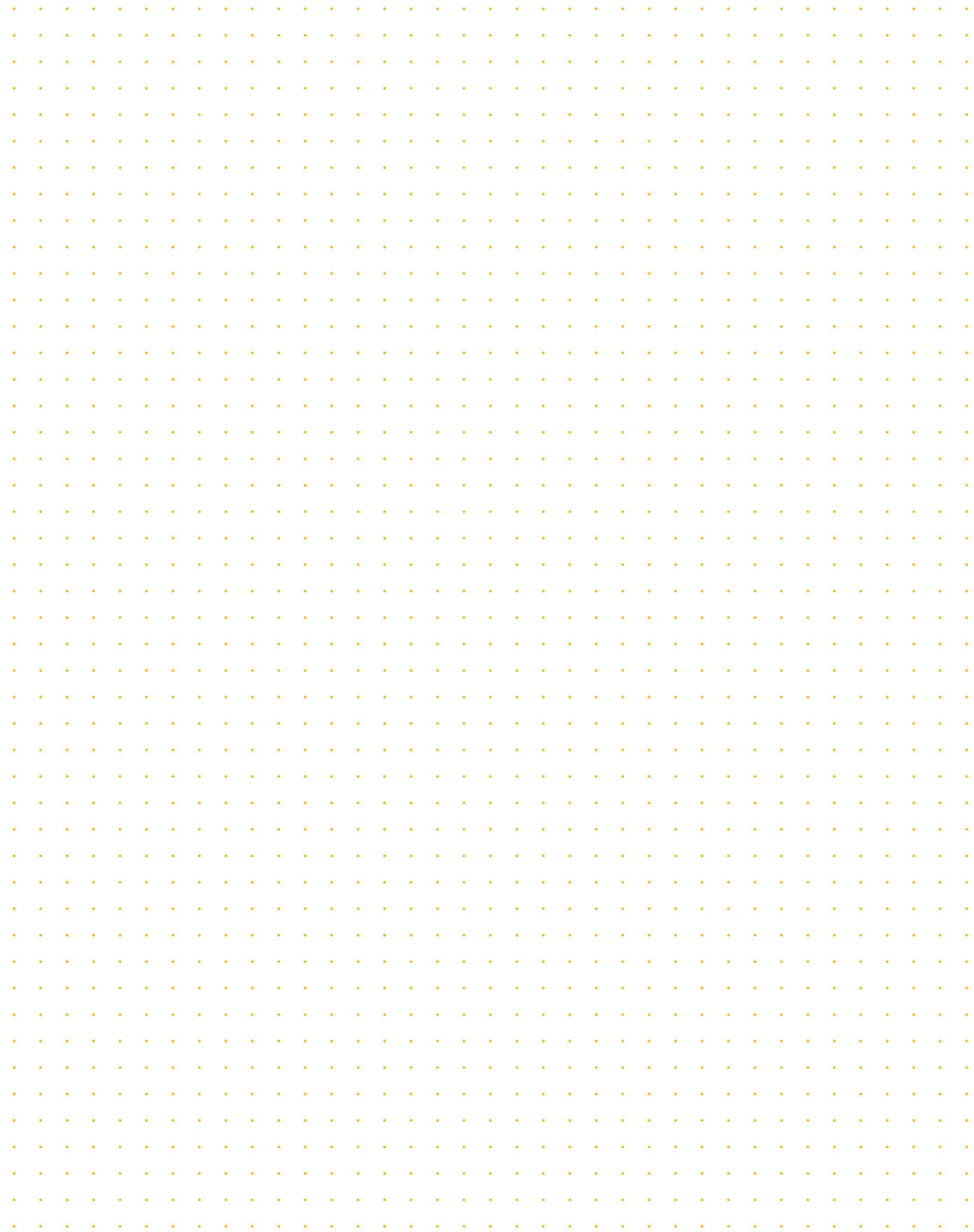

EXTRACT OF OUR  
PRODUCT PORTFOLIO

我们的其他产品



industrial  
工业



Connector DIN-EN  
DIN-EN连接器



Valve Timer  
阀定时器



Pressure Switch  
Electronic  
液压压力开关



Pressure Switch  
Hydraulic  
液压压力开关



Pressure Switch  
Pneumatic  
气压压力开关



automotive  
汽车



Delphi Connector  
Delphi连接器



Deutsch Connector  
Deutsch连接器



JPT Connector  
JPT连接器



ST3 Connector  
ST3连接器



Superseal  
Connector  
Superseal连接器



automation  
自动化



Connector M12  
M12连接器



Connector M12  
M12连接器



M12 Actuator/  
Sensor-Box  
M12执行器 /  
传感器连接盒



M8 Actuator/  
Sensor-Box  
M8执行器 /  
传感器连接盒



Connector M12  
Field attachable  
M12总线连接连接  
器

# PERFECT SOLUTIONS BY GERMAN ENGINEERING

[www.peters-indu.de](http://www.peters-indu.de)



**Peters Indu-Produkt GmbH**  
Mercatorstrasse 41  
46485 Wesel  
Germany

T +49 (0)281.9546 0  
F +49 (0)281.9546 30



[info@peters-indu.de](mailto:info@peters-indu.de)  
[www.peters-indu.de](http://www.peters-indu.de)

彼德氏工业（上海）  
上海市松江区莘砖公路 518  
号24号楼101室 邮编：201612

电话 +86-21-6256-8359  
传真 +86-21-6255-2545



[china@peters-indu.de](mailto:china@peters-indu.de)  
[www.peters-indu.de](http://www.peters-indu.de)